1. PURPOSE

- 1.1 The purpose of this document is to provide procedures and basic instructions for installing the Proglaze® ETA System 3 (hereinafter Proglaze ETA) in pressure-bar glazing systems. The techniques involved may require modifications to adjust to job site conditions. Please contact your Tremco representative for specific design requirements.

2. SCOPE

- 2.1 The scope of this document is specific to installation of Proglaze ETA and does not include proper installation of the Tremco ExoAir® Air Barrier Membrane System. Refer to the applicable Tremco ExoAir Air Barrier Membrane Installation Instructions at www.tremcosealants.com.
- 2.2 This document provides the instructions for installation of Proglaze ETA in pressure-bar systems as would qualify for Tremco's warranty. Tremco recognizes that site specific conditions, weather patterns, contractor preferences and detailing may require deviation from these prescribed installation procedures. When such circumstances exist on a project, Tremco recommends that the local Tremco Sales Representative or Technical Services be contacted for assistance and approval as required.
- 2.3 Proglaze ETA may be shop- or field-applied. This document is specific to field-applied installations.

3. CONDITIONS

3.1 Reviews and Approvals

- a. Tremco Engineering Review: This document assumes that Tremco Engineering has reviewed the window and/or curtain wall system shop drawings and architectural drawings of adjacent construction assemblies and has addressed proper interfacing of them.
- b. Window/Wall Manufacturer Approval: This document shows the sequencing of Proglaze ETA connected to a window/curtain wall system used as a punched window application. The window/wall manufacturer must approve the installation and modifications required for Proglaze ETA to be used. Tremco Engineering is available to assist with navigating approval by the window/wall manufacturer.
- c. Adhesion and Compatibility Verification: Proglaze ETA and Spectrem® 1 are compatible with most silicone sealants and metallic glazing materials with which they would come into contact. Where Proglaze ETA will cover or come into contact with pre-applied sealants, glazing components or unverified construction materials the intercompatibilities and/or adhesion must be reviewed and verified. Samples can be submitted to Tremco Technical Services for in-house laboratory compatibility and adhesion testing.
- d. Proglaze ETA components are typically bonded directly to the liner face of ExoAir 110 membranes as well as the cured surface of ExoAir 230 membrane using Spectrem 1 silicone sealant. Adhesion must be verified on all other interconnecting substrates to ensure that the proper sealing will be achieved. Adhesion testing must be conducted on-site to verify adhesion. Consult with your local Tremco Sales Representative for assistance.

3.2 Surface Preparation

- a. The adjoining surfaces of Proglaze ETA components and substrates must be cleaned by solvent wipe using IPA poured onto a clean, white, lint-free rag followed immediately by dry wipe using a clean, white, lint-free rag.
- b. The liner faces of ExoAir 110 are best cleaned using a single pass of the solvent wipe followed immediately by dry wipe.
- c. The selvage edge of ExoAir 110 membrane provide a selfterminating edge bead of rubberized asphalt and must not be directly overlaid with Proglaze ETA components. No asphalt-based mastic is to be used to treat edges of the membrane where directly overlaid by Proglaze ETA components. To avoid contact with these asphaltic surfaces it is advised that the air barrier membrane installer be made aware of this. To mitigate such asphaltic contact, Tremco recommends the following preparation prior to receiving Proglaze ETA components.

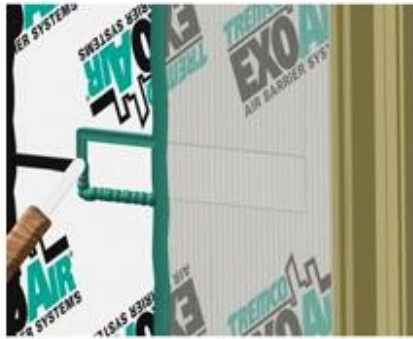

(Figure 1)



(Figure 2)

- d. As shown in figure 1, overlay an exposed asphaltic edge with a strip of membrane extending a minimum of 2" (5 cm) beyond the edge of the Proglaze ETA component. Treat all cut edges with Spectrem 1.
- e. For cut edges of ExoAir 110 that are beneath the Proglaze ETA component, use Spectrem 1 in place of ExoAir Termination Mastic for detailing both beneath the component and extending 2" (5 cm) beyond the leading edge. See figure 2.

3.3 Priming: Where required to achieve satisfactory bonding adhesion, follow substrate cleaning with application of the appropriate Tremco primer. When applying Tremco Silicone Metal Primer 10 to a nonporous substrate, use a clean white rag so surface is wetted; if overapplied, a white film appears upon drying which must be wiped off and then the Primer 10 re-applied. Allow primer to dry as directed.

4. MATERIALS

4.1 Recommended materials and their uses are as follows:

- a. Spectrem 1 Silicone Sealant: A low-modulus, high-performance, one-part, moisture-curing silicone joint sealant. Bedding sealant is estimated at 1 oz per lineal foot of Proglaze ETA components, which accounts for two 1" (2.5 cm) wide bedding beads.
- b. Proglaze ETA System 3 A/B Silicone Molded Corners: 40-durometer, premolded translucent silicone corners. Left (A) and right (B) hand corners are ordered separately and are packaged 8 per bag.

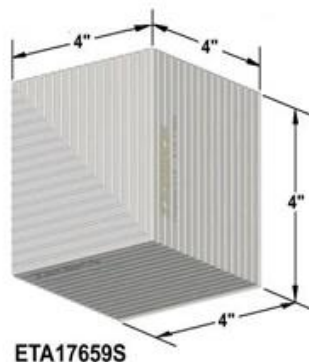
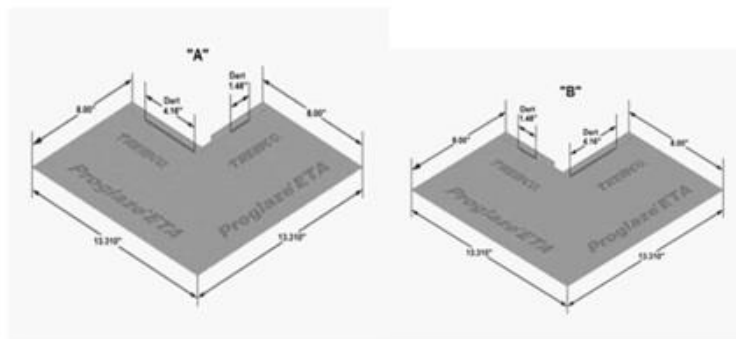

Inside Corner

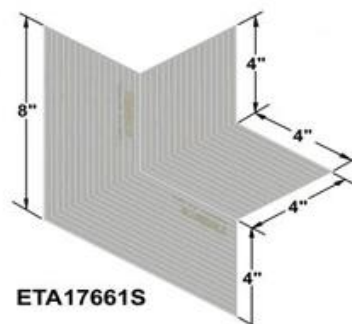

Outside Corner

- c. Proglaze ETA 3-D Silicone Molded Corners: 40-durometer, pre-molded translucent silicone inside and outside corners ordered separately and packaged 4 per bag.
- d. Proglaze ETA Silicone Rubber Extrusion: 40-durometer dense translucent ribbed silicone sheet in width required for application.

5 PROGLAZE ETA INSTALLATION

- 5.1 Installation should begin at the bottom of the unit following typical construction practices of proper shingle lapping.
- 5.2 Figure 3 shows the suggested sequencing of the Proglaze ETA components.
- 5.3 The metal assembly should already have been fabricated (modified) to receive all components of Proglaze ETA. Vertical mullion must have the mullion stem milled away, leaving a continuous bonding surface for Proglaze ETA to transition from the vertical to the horizontal member as shown in figure 4.

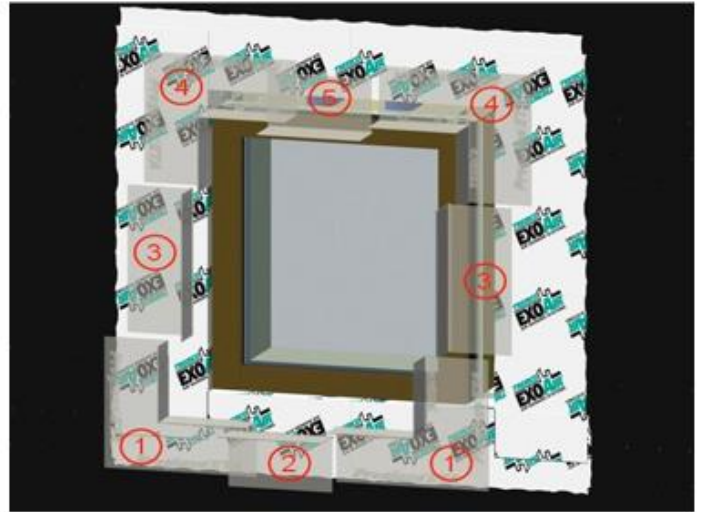

(Figure 3)

- 5.4 Pre-plan installation of the components to ensure measurement of cut lengths are correct to achieve the 1" (2.5 cm) overlaps. It is not necessary to add extra material (crowd factor) to these extrusions to account for relaxation. These silicone extrusions are easily stretched, which should be avoided or minimized during handling. Extrusions should be cut on a clean, flat, horizontal surface to minimize any stretching and avoid dirt pick-up. Tremco recommends using scissors instead of utility knife to achieve straight square cuts and the ability to trim the dart off at overlaps.
- 5.5 Bonding/Bedding: Bonding of Proglaze ETA components is achieved with continuous and inter-connecting beads of Spectrem 1 silicone sealant. Provide 1" (2.5 cm) wide continuous bedding along leading edges at the air/water barrier membrane and within overlaps. Provide a minimum 3/8" (9 mm) wide continuous bedding along leading edges at window frames. Gun the bonding bead of Spectrem 1 alongside the raceway rather than in it.
- 5.6 Install only as much Spectrem 1 silicone sealant as can be used prior to skinning. Working time will be impacted by temperature and humidity.
- 5.7 Bed the Proglaze ETA component into the bonding bead. Press the component dart into the raceway, bringing with it some of the sealant, while setting the leading edge of the component into the bead. Using a hand-held seam roller, lightly roll-press the Proglaze ETA component to firmly bed, rolling toward its leading edge to force some sealant out creating a slight bleed. Maintain a body of sealant beneath the Proglaze ETA component. Tool the bled sealant back onto the Proglaze ETA component to encapsulate the leading edge and ensure water-shed drainage.
- 5.8 Install a continuous bonding bead of Spectrem 1 silicone sealant to the Extruded Aluminum Adaptor extending approximately 5" (12.5 cm) from the corner in both directions and bed the Proglaze ETA Molded Corner. Install a bonding bead of Spectrem 1 at the barrier system and bed the other leading edge of the Proglaze ETA Molded Corner as shown in figure 5.



(Figure 4)

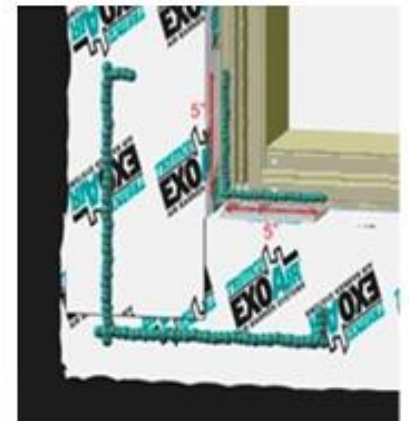

(Figure 5)

5.9 The Proglaze ETA Silicone Molded Corner is bedded into the silicone sealant. The darts in the Molded Corner are inserted into the mullion races, which properly positions the component. The bedding silicone sealant must be compressed and forced out along the Proglaze ETA component edges to ensure good contact and to prevent water and/or debris from collecting behind it. See figure 6.

5.10 The Proglaze ETA Silicone Rubber Extrusion is cut to length allowing for a 1" (2.5 cm) overlap with the Proglaze ETA Silicone Molded Corner. Trim back the dart on the Proglaze ETA Silicone Rubber Extrusion where required to provide for the 1" overlap. See figure 7.

5.11 Install a continuous bonding sealant bead along the remaining horizontal mullion race and bed the Proglaze ETA Silicone Rubber Extrusion. Install a continuous bonding sealant bead at the adjacent air barrier and within the component overlap, and bed the leading edges of the Proglaze ETA Silicone Rubber Extrusion. See figures 8 and 9.



(Figure 6)



(Figure 7)



(Figure 8)

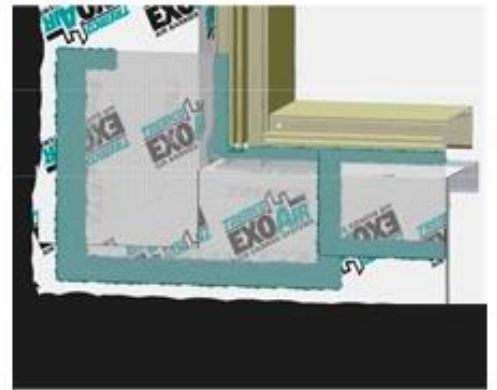

(Figure 9)

5.12 Silicone sealant is applied at the Proglaze ETA Silicone Rubber Extrusion's end for bonding within the 1" (2.5 cm) overlap with the Proglaze ETA Silicone Molded Corner. The Proglaze ETA Silicone Molded Corner is bedded into the silicone sealant. See figure 10.

5.13 Install a continuous bonding sealant bead along the remaining horizontal mullion race and bed the Proglaze ETA Silicone Rubber Extrusion. Install a continuous bonding sealant bead at the adjacent air barrier and within the component overlap and bed the leading edges of the Proglaze ETA Silicone Rubber Extrusion. Tool the sealant bleed back onto the Proglaze ETA components to encapsulate the leading edge and ensure water-shed drainage. Apply additional sealant if needed. See figures 11 and 12.



(Figure 10)

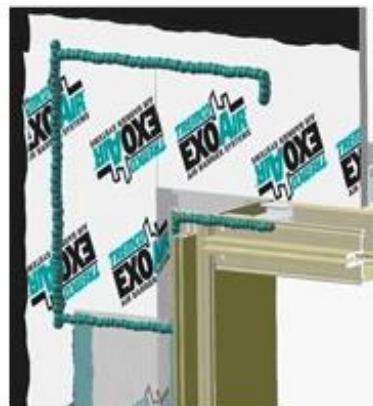

(Figure 11)

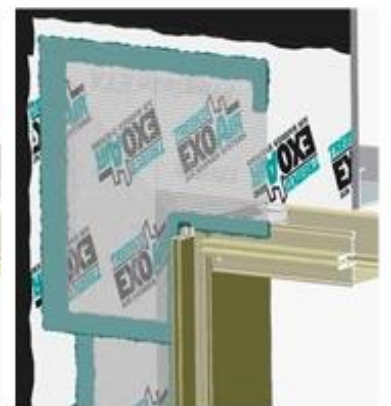

(Figure 12)

5.14 Installation of the curtainwall system and adjacent façade may continue following the manufacturer's recommended procedures. See figures 13 and 14.

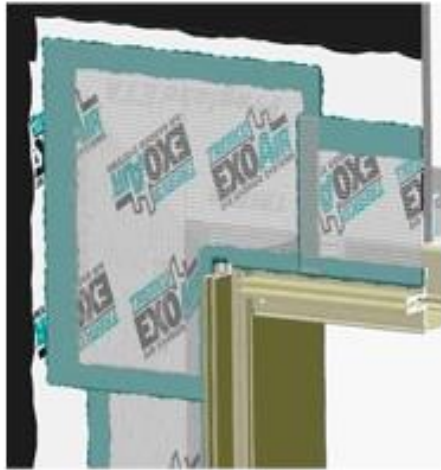

(Figure 13)



(Figure 14)

5.15 Typical cross-section of a pressure-bar system. See figure 15.

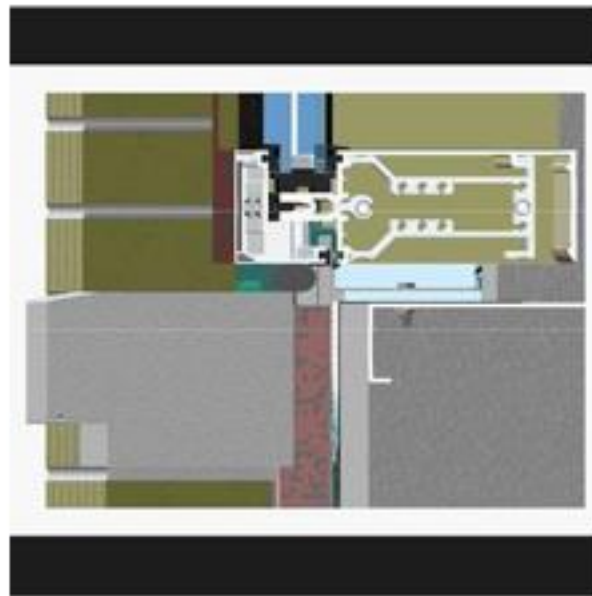

(Figure 15)

6. REPAIR PROCEDURES/SYSTEM ALTERNATIVES

- 6.1 In some applications, the Proglaze ETA Silicone Molded Corner may not lay flat on the wall surface and may require mechanical fasteners to properly secure the component while the silicone sealant is curing. Silicone sealant must be applied both under and over these fastener locations. A sufficient volume (not a thin film) of silicone sealant must be applied over fasteners.
- 6.2 For complex conditions where use of a Silicone Molded Corner would be difficult, Proglaze ETA 3-D Silicone Molded Corners are available.

7. SYSTEM ALTERNATIVES

- 7.1 For applications where the window/wall is cantilevered from the opening, the following sequence of installation may be followed using the same procedures outlined above. See figures 16- 38 on following pages.



(Figure 16)

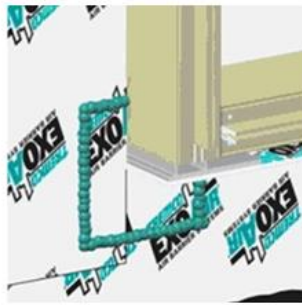

(Figure 17)

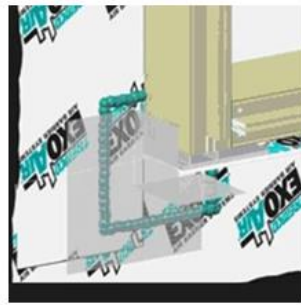

(Figure 18)

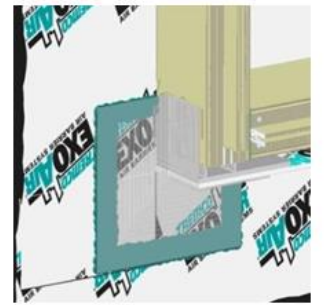

(Figure 19)

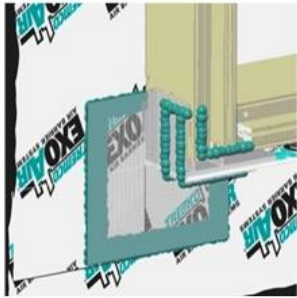

(Figure 20)

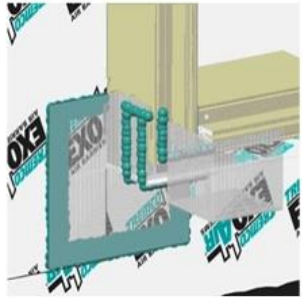

(Figure 21)

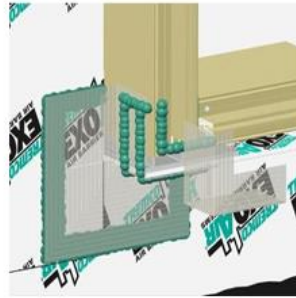

(Figure 22)

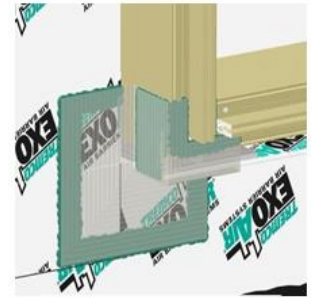

(Figure 23)



(Figure 24)

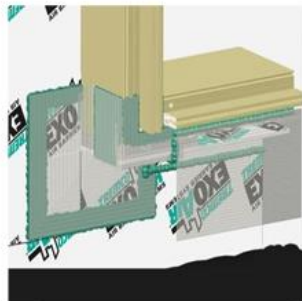

(Figure 25)

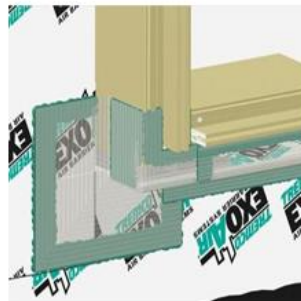

(Figure 26)

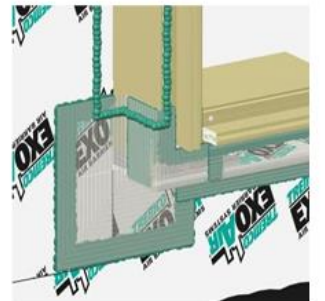

(Figure 29)



(Figure 28)



(Figure 30)



(Figure 27)

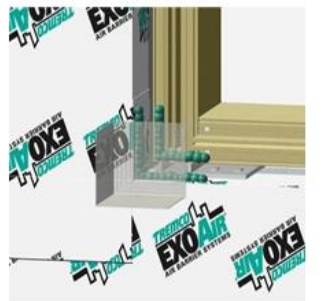

(Figure 31)



(Figure 32)



(Figure 33)



(Figure 34)

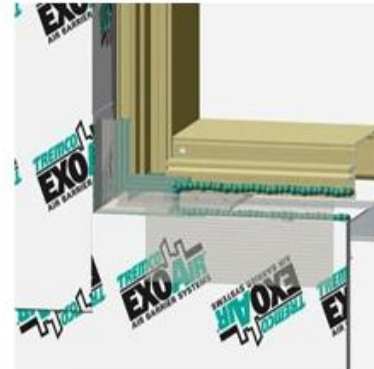

(Figure 35)



(Figure 36)



(Figure 37)

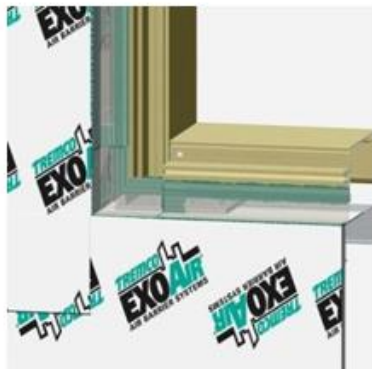

(Figure 38)

8. REPAIR PROCEDURES

8.1 If conditions on the jobsite result in a tear or puncture to a Proglaze ETA component, it can be repaired using the following technique:

8.2 Apply Spectrem 1 silicone sealant over the puncture and cut a patch of silicone extrusion $\frac{1}{4}$ " to $\frac{1}{2}$ " wider than the hole or tear in all directions. Embed the repair patch completely into the silicone sealant and compress firmly ensuring the sealant squeezes out around the perimeter of the patch. Tool leading edge of the sealant.

PETAS3-AI/0423

Tremco Construction Products Group (CPG) brings together the Commercial Sealants & Waterproofing and Roofing & Building Maintenance divisions of Tremco CPG Inc.; Dryvit, Nudura and Willseal brands; Prebuck LLC; Tremco Barrier Solutions, Inc.; Weatherproofing Technologies, Inc.; Weatherproofing Technologies Canada, Inc.; and Pure Air Control Services, Inc.



tremcosealants.com | 800.321.7906



Construction Products Group

3735 Green Rd. | Beachwood, OH 44122
800.321.7906 | tremcocpg.com